

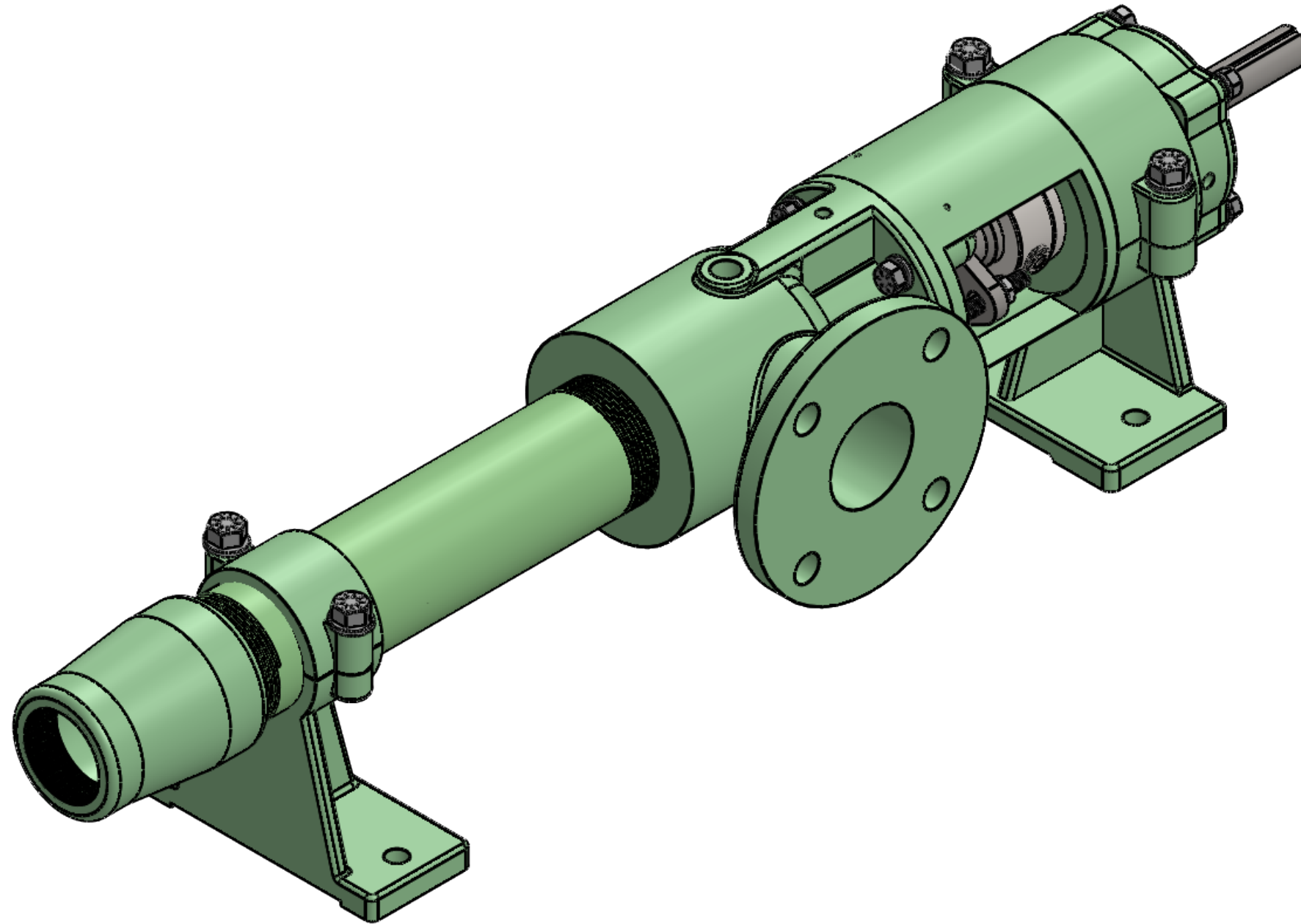

SUCTION ROTATED 270 DEGREES

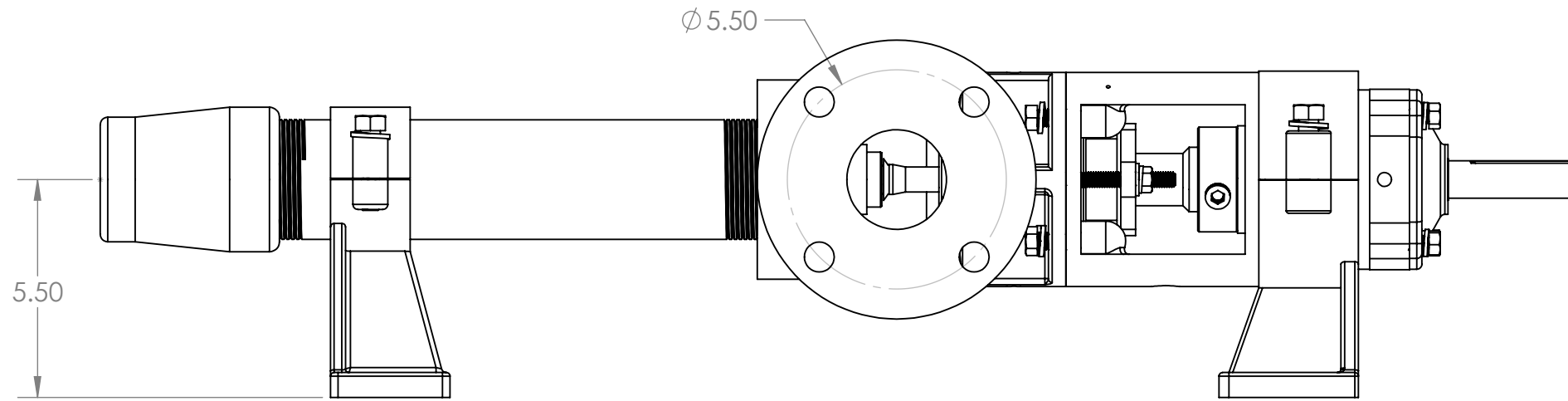

USED ON:	DRAWN BY: HUNTER TANKERSLEY	CONTINENTAL PUMP COMPANY 29425 STATE HIGHWAY B WARRENTON, MISSOURI 63383 PHONE: (636) 456-6006 FAX: (636) 456-4337 www.continentalultrapumps.com
MATERIAL:	DATE: 1/9/2025	
UNLESS OTHERWISE SPECIFIED: DIMENSIONS ARE IN INCHES TOLERANCES: FRACTIONAL ± ANGULAR: MACH ± BEND ± TWO PLACE DECIMAL ± THREE PLACE DECIMAL ±	PROPRIETARY AND CONFIDENTIAL THE INFORMATION CONTAINED IN THIS DRAWING IS THE SOLE PROPERTY OF CONTINENTAL PUMP COMPANY. ANY REPRODUCTION IN PART OR AS A WHOLE WITHOUT THE WRITTEN PERMISSION OF CONTINENTAL PUMP COMPANY IS PROHIBITED.	TITLE: 2CL4 ASSEMBLY DRAWING
	SIZE DWG. NO.	REV -
DO NOT SCALE DRAWING		SHEET 1 OF 2

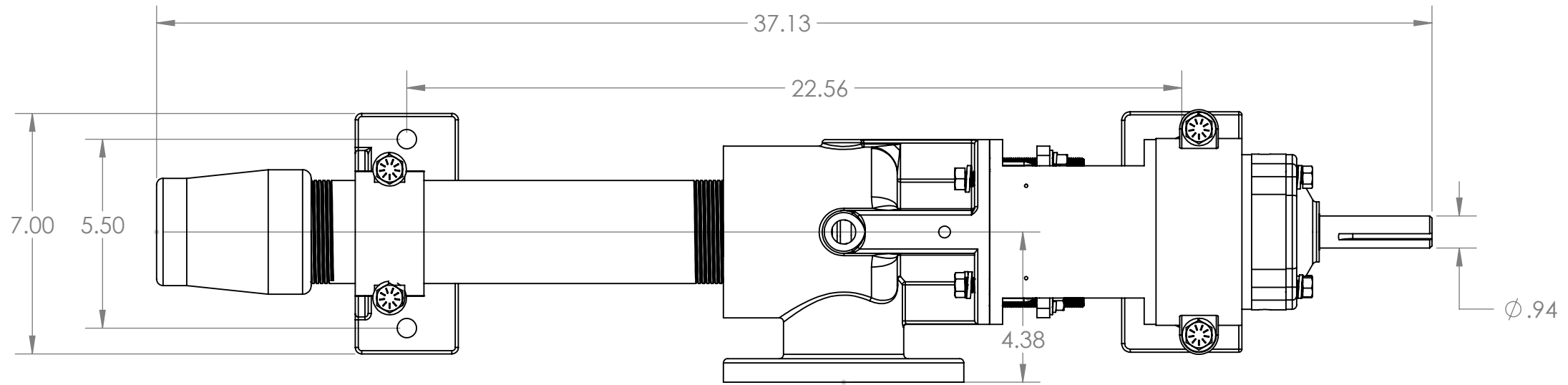

**SUCTION SIZE - 2.5" 150# FLANGE
DISCHARGE SIZE - 2" NPT**

USED ON:	DRAWN BY: HUNTER TANKERSLEY	CONTINENTAL PUMP COMPANY 29425 STATE HIGHWAY B WARRENTON, MISSOURI 63383 PHONE: (636) 456-6006 FAX: (636) 456-4337 www.continentalultrapumps.com
MATERIAL:	DATE: 1/9/2025	
UNLESS OTHERWISE SPECIFIED: DIMENSIONS ARE IN INCHES TOLERANCES: FRACTIONAL ± ANGULAR: MACH ± BEND ± TWO PLACE DECIMAL ± THREE PLACE DECIMAL ±	PROPRIETARY AND CONFIDENTIAL THE INFORMATION CONTAINED IN THIS DRAWING IS THE SOLE PROPERTY OF CONTINENTAL PUMP COMPANY. ANY REPRODUCTION IN PART OR AS A WHOLE WITHOUT THE WRITTEN PERMISSION OF CONTINENTAL PUMP COMPANY IS PROHIBITED.	TITLE: 2CL4 ASSEMBLY DRAWING
		SIZE DWG. NO. REV -
		DO NOT SCALE DRAWING SHEET 2 OF 2